



*Beyond Your  
Imagination...*



## The Sanitaryware showcase

The Sanitary ware showcase of the [redacted] presents the finest sanitary ware reserved exclusively for the modern trend. These are closets, counter tops and basins that are adorned with class and sophistication and only those with taste would choose to spurge all over. The main ingredient of this collection is the richness of design that stands way above other contemporary offerings.





# CONTENTS

One Piece Closet	12
Wall Hung Closet	28
EWC Back to Wall	34
EWC Floor Mount	36
Table Tops	40
Wall Hung Basin	60
One Piece Basin	68
Wash Basin Pedestal	76
Half One Piece Basin	88
Counter Basin	90
Urinal	92
Orissa Pan	94
Accessories	95
Designer	96



**MARCO-S**

One Piece Closet  
26" x 14" x 30"  
Center of outlet to wall 9"

**SESA**

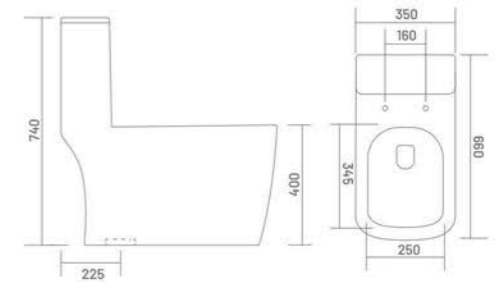
One Piece Basin  
15" x 15" x 34"

# CLOSETS



**MARCO-S (Syphonic)**  
 One Piece Closet  
 26" x 14" x 30"  
 Center of outlet to wall 9"

-  SYPHONIC FLUSH
-  RIMLESS DESIGN
-  TORNADO FLUSH
-  SOFT CLOSE SEAT COVER
-  DUAL FLUSH
-  WATER SAVING
-  ANTI BACTERIAL



**RIMLESS DESIGN** ▶

 MORE HYGIENIC

 MORE ECOLOGICAL

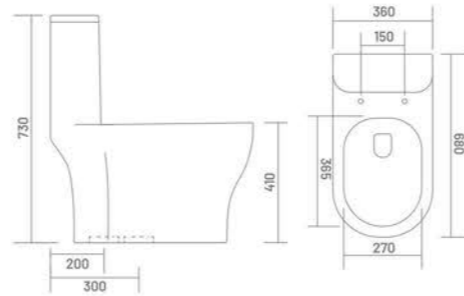




### AUDI-S (Syphonic)

One Piece Closet  
28" x 16" x 30"  
Center of outlet to wall 8"/12"

-  SYPHONIC FLUSH
-  RIMLESS DESIGN
-  TORNADO FLUSH
-  SOFT CLOSE SEAT COVER
-  DUAL FLUSH
-  WATER SAVING
-  ANTI BACTERIAL



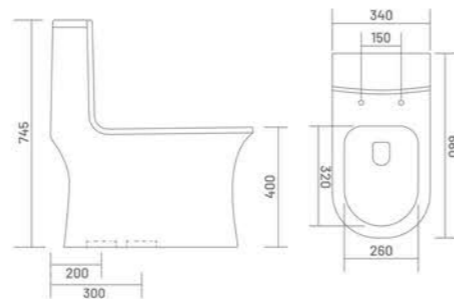
**4D** - FLUSHING TECHNOLOGY



### LUNAR-S (Syphonic)

One Piece Closet  
26" x 15" x 30"  
Center of outlet to wall 8"/12"

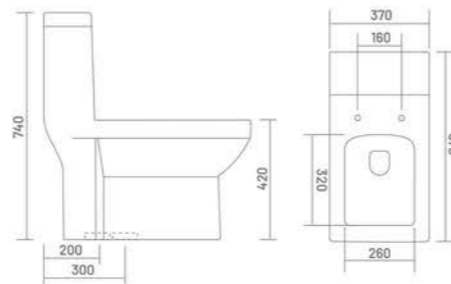
-  SYPHONIC FLUSH
-  RIMLESS DESIGN
-  TORNADO FLUSH
-  SOFT CLOSE SEAT COVER
-  DUAL FLUSH
-  WATER SAVING
-  ANTI BACTERIAL





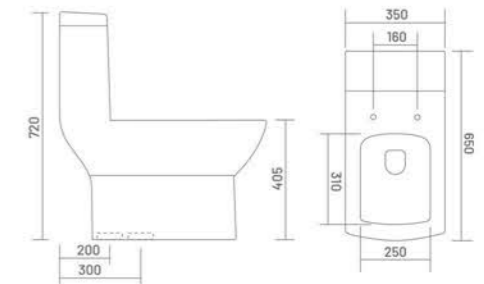
### RADO-S (Syphonic)

One Piece Closet  
26" x 15" x 30"  
Center of outlet to wall 8"/12"



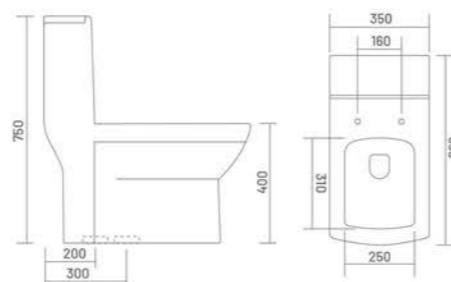
### AMEO-S (Syphonic)

One Piece Closet  
26" x 14" x 31"  
Center of outlet to wall 8"/12"



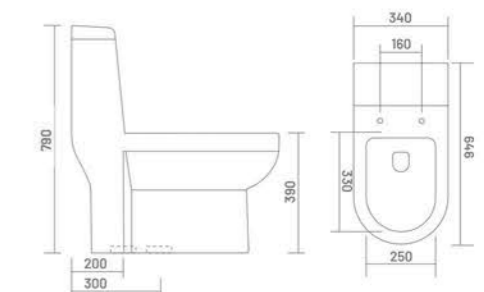
### PAJERO-S (Syphonic)

One Piece Closet  
26" x 14" x 30"  
Center of outlet to wall 8"/12"



### BRAVO-S (Syphonic)

One Piece Closet  
25" x 14" x 30"  
Center of outlet to wall 8"/12"

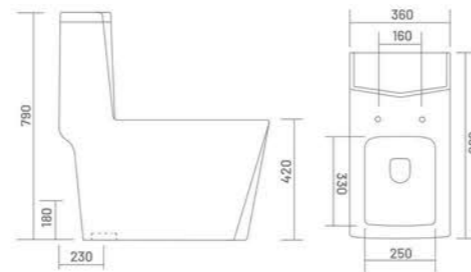






### DIAMOND-S/P

One Piece Closet  
26" x 14" x 31"  
Center of outlet to wall 9"

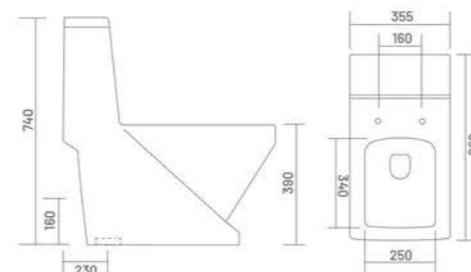


SHAPE  
FOR NEXT  
GENERATION



### SOSEN-S/P

One Piece Closet  
26" x 14" x 29"  
Center of outlet to wall 9"



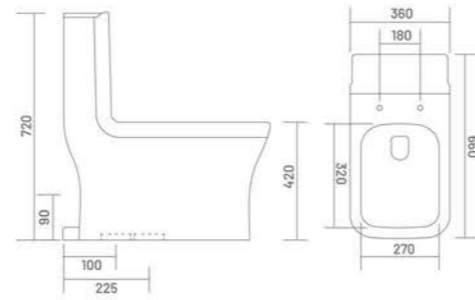


### SCOP-S/P

One Piece Closet  
26" x 14" x 29"  
Center of outlet to wall 4"/9"

- WASH DOWN  
FLUSH
- SOFT CLOSE  
SEAT COVER
- DUAL  
FLUSH
- WATER  
SAVING
- ANTI  
BACTERIAL

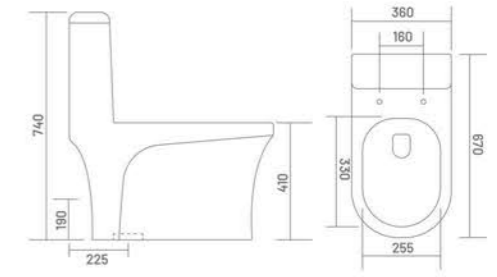
INBUILT JET



### COCO-S/P

One Piece Closet  
26" x 14" x 29"  
Center of outlet to wall 9"

- WASH DOWN  
FLUSH
- SOFT CLOSE  
SEAT COVER
- DUAL  
FLUSH
- WATER  
SAVING
- ANTI  
BACTERIAL

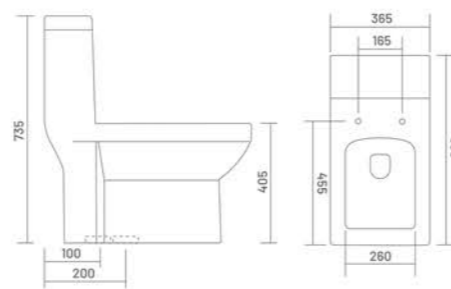


NEW ARRIVAL

### TESLA

One Piece Closet  
26" x 15" x 30"  
Center of outlet to wall 4"/9"

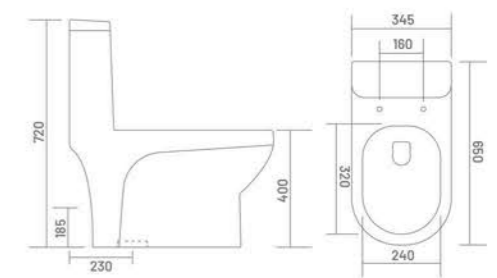
- WASH DOWN  
FLUSH
- SOFT CLOSE  
SEAT COVER
- DUAL  
FLUSH
- WATER  
SAVING
- ANTI  
BACTERIAL



### VIVA-S/P

One Piece Closet  
26" x 14" x 29"  
Center of outlet to wall 9"

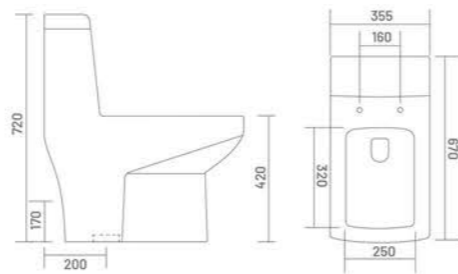
- WASH DOWN  
FLUSH
- SOFT CLOSE  
SEAT COVER
- DUAL  
FLUSH
- WATER  
SAVING
- ANTI  
BACTERIAL





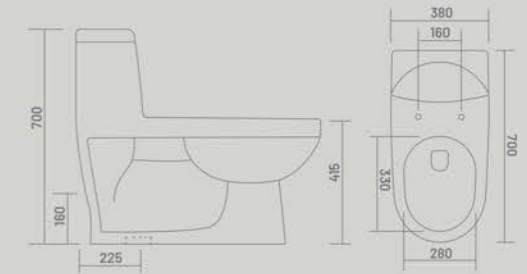
### VEGA-S/P

One Piece Closet  
26" x 14" x 29"  
Center of outlet to wall 9"/12"



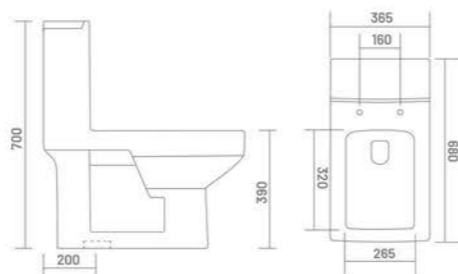
### VENTO-S/P

One Piece Closet  
28" x 15" x 28"  
Center of outlet to wall 9"



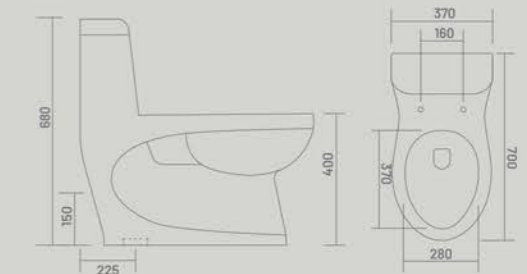
### COSMO-S

One Piece Closet  
27" x 14" x 29"  
Center of outlet to wall 9"



### POLO-S/P

One Piece Closet  
28" x 15" x 27"  
Center of outlet to wall 9"



# RIMLESS-DESIGN

## TOILET BOWL WITHOUT AN EDGE

The rimless design is standard for all special toilets. It means that the toilet bowls do not have any difficult-to-reach places in which dirt and bacteria can accumulate. This makes it possible to clean the toilet far more quickly, easily and thoroughly. SENISTO has produced rimless toilet bowls.



TRADITIONAL DESIGN



SENISTO DESIGN



MORE HYGIENIC



MORE ECOLOGICAL

## EASY TO CLEAN



Glazed Siphon



More Silent



Soft Close





**IBIS**

Wall Hung Closet  
23" x 14" x 15"



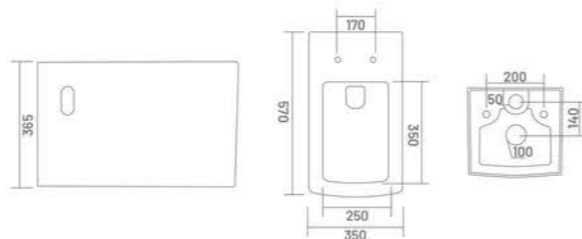
**INFINITY**

Table Top Basin  
16" x 16" x 5"



**IBIS**  
Wall Hung Closet  
23" x 14" x 15"

SOFT CLOSE SEAT COVER ANTI BACTERIAL

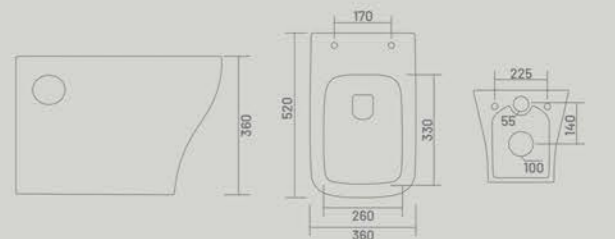


INBUILT JET



**SMITH**  
Wall Hung Closet  
21" x 14" x 14"

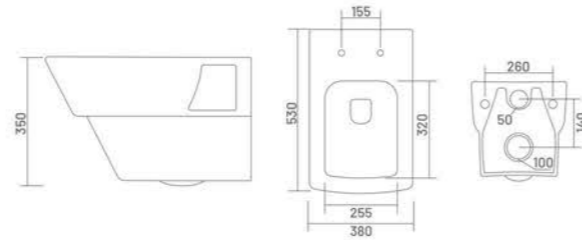
SOFT CLOSE SEAT COVER ANTI BACTERIAL



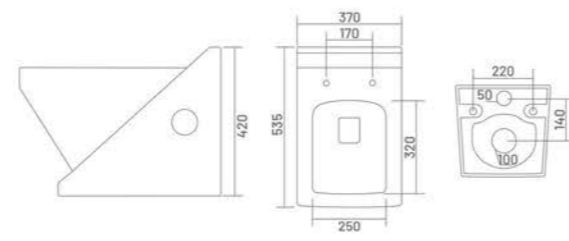
INBUILT JET



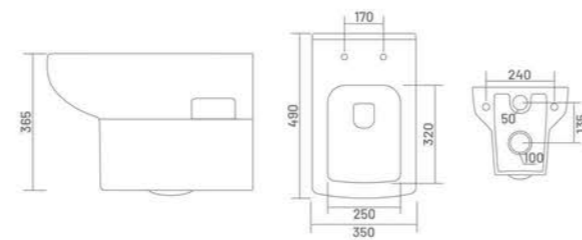
**ACCORD**  
Wall Hung Closet  
21" x 15" x 14"



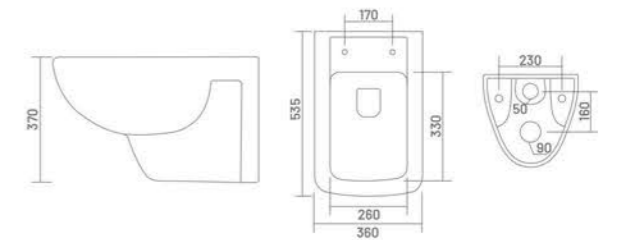
**SANITO**  
Wall Hung Closet  
21" x 15" x 17"



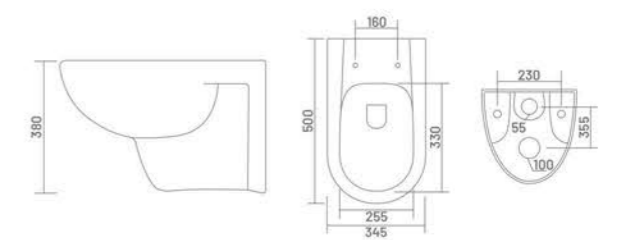
**SOYOTO**  
Wall Hung Closet  
19" x 14" x 15"



**ALTO**  
Wall Hung Closet  
21" x 14" x 15"



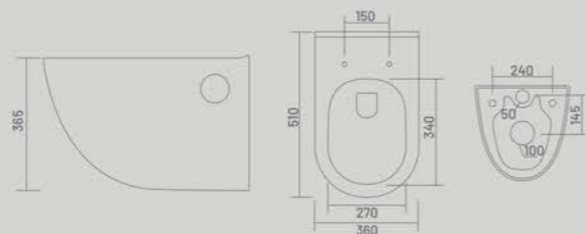
**ENIGMA**  
Wall Hung Closet  
19" x 14" x 15"





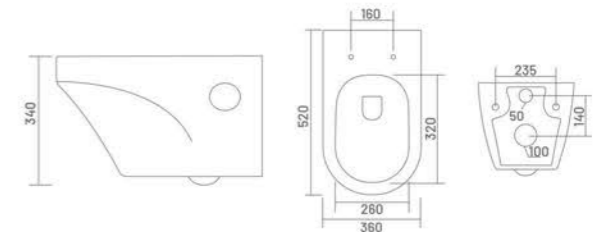
**ROB**  
Wall Hung Closet  
20" x 14" x 15"

-  RIMLESS DESIGN
-  SOFT CLOSE SEAT COVER
-  ANTI BACTERIAL



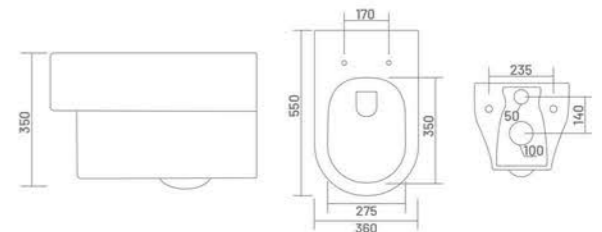
**CLASSIC**  
Wall Hung Closet  
21" x 14" x 14"

-  RIMLESS DESIGN
-  SOFT CLOSE SEAT COVER
-  ANTI BACTERIAL



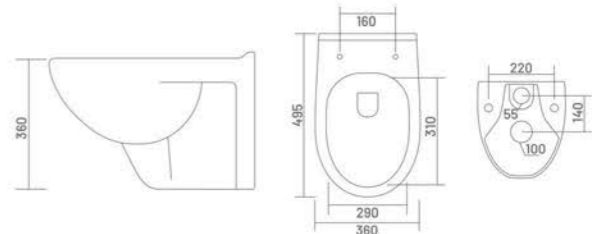
**OTTO**  
Wall Hung Closet  
22" x 14" x 14"

-  SOFT CLOSE SEAT COVER
-  ANTI BACTERIAL



**BABY**  
Wall Hung Closet  
19" x 14" x 14"

-  RIMLESS DESIGN
-  SOFT CLOSE SEAT COVER
-  ANTI BACTERIAL

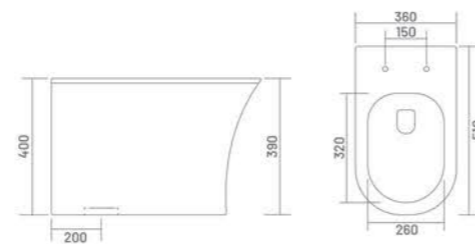






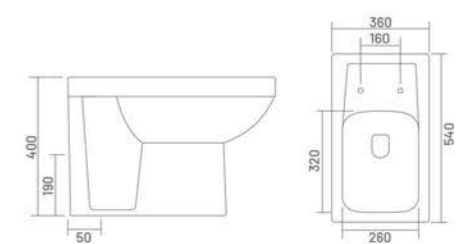
**LUMINA-S (Syphonic)**  
EWC Back to Wall  
20" x 14" x 16"

- SYPHONIC FLUSH
- RIMLESS DESIGN
- TORNADO FLUSH
- SOFT CLOSE SEAT COVER
- WATER SAVING
- ANTI BACTERIAL

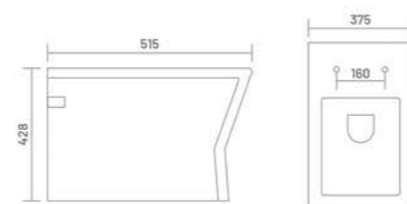


**KENZO-S/P**  
EWC Back to Wall  
22" x 14" x 16"

- SOFT CLOSE SEAT COVER
- ANTI BACTERIAL

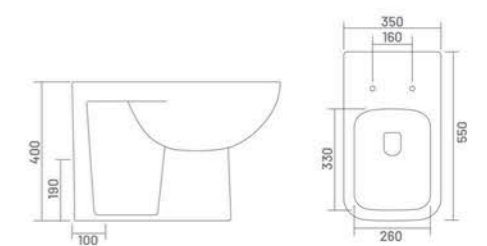


**LIVA**  
EWC Back to Wall  
00" x 00" x 00"



**KOBRA-S/P**  
EWC Back to Wall  
22" x 14" x 16"

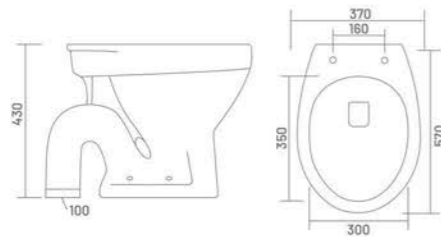
- SOFT CLOSE SEAT COVER
- ANTI BACTERIAL





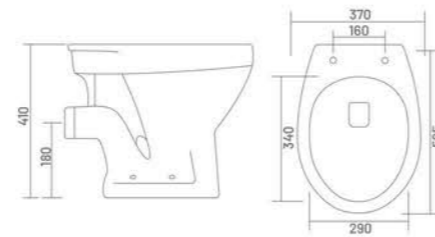
**PERRYWARE E.W.C.-S**

EWC Floor Mount  
23" x 15" x 17"



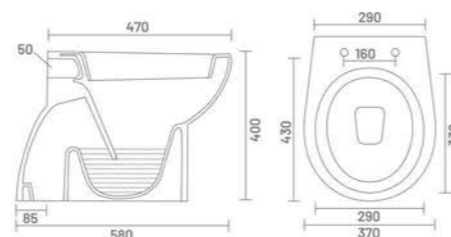
**PERRYWARE E.W.C.-P**

EWC Floor Mount  
21" x 15" x 17"



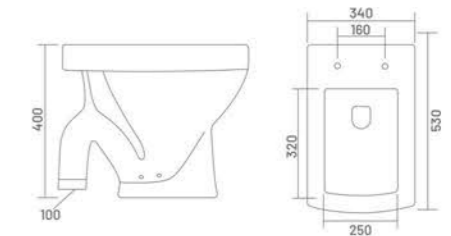
**SELVO CONCEALED E.W.C.-S**

EWC Floor Mount  
00" x 00" x 00"



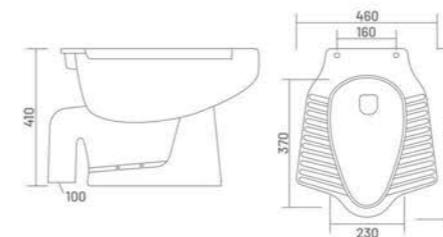
**TORO-S**

EWC Floor Mount  
21" x 14" x 16"



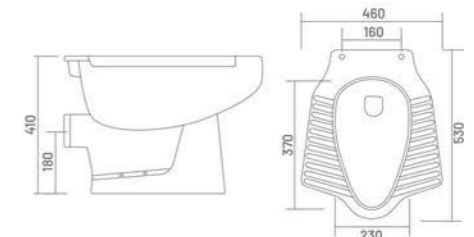
**ANGLO INDIAN E.W.C.-S**

EWC Floor Mount  
23" x 18" x 16"



**ANGLO INDIAN E.W.C.-P**

EWC Floor Mount  
21" x 18" x 16"





**KENZO-S/P**

EWC Back to Wall  
22" x 14" x 16"



**ROCKET**

Table Top Basin  
25" x 16" x 5"

TABLE TOP

TABLE TOP

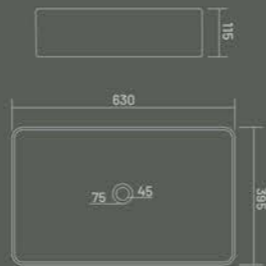


**ROCKET**

Table Top Basin  
25" x 16" x 5"



THIN RIM  
DESIGN



5mm Thickness

**THIN RIM**

Elegant THIN EDGE basin with fine edges that is only 5 mm in thickness. The Attractive clay art is made by the innovative material used by SENISTO.

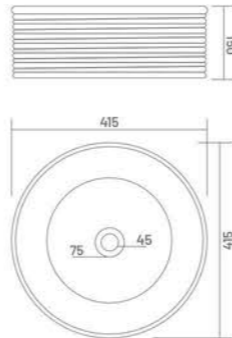




NEW ARRIVAL



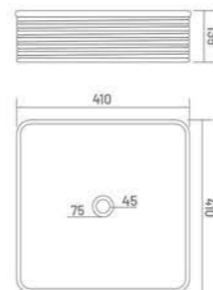
**OCEAN**  
Table Top Basin  
16" x 16" x 6"



NEW ARRIVAL

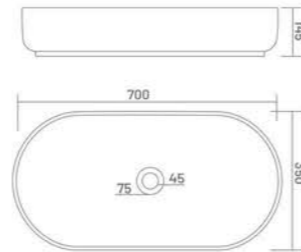


**INFINITY**  
Table Top Basin  
16" x 16" x 5"

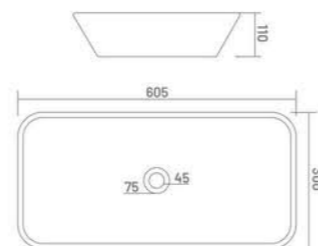




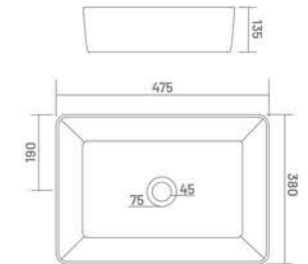
**TOPIC**  
Table Top Basin  
28" x 14" x 5"



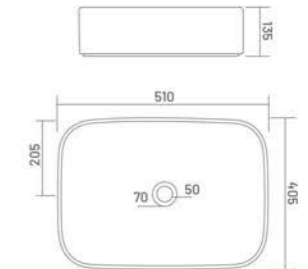
**ABRA**  
Table Top Basin  
00" x 00" x 00"



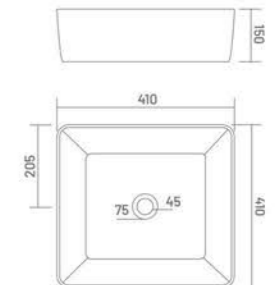
**CROMA**  
Table Top Basin  
19" x 15" x 5"



**RADON**  
Table Top Basin  
20" x 16" x 5"

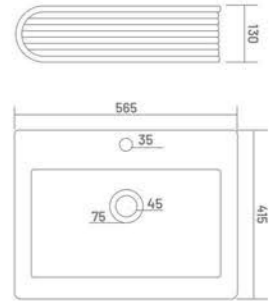


**SOLEX**  
Table Top Basin  
00" x 00" x 00"

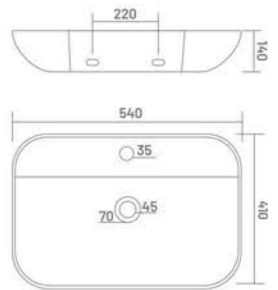




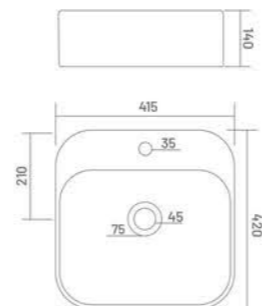
**SMART**  
Table Top / Wall Hung Basin  
23" x 17" x 5"



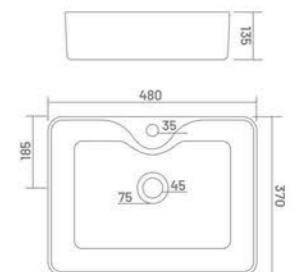
**BREZZA**  
Table Top / Wall Hung Basin  
22" x 16" x 5"



**EURO**  
Table Top / Wall Hung Basin  
16" x 16" x 5"



**SWIFT**  
Table Top Basin  
20" x 15" x 5"

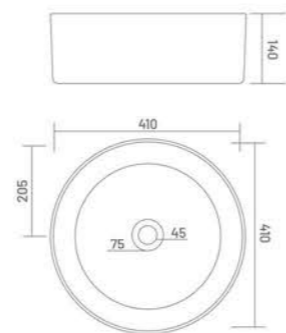




**ZERO**  
Table Top Basin  
16" x 16" x 6"



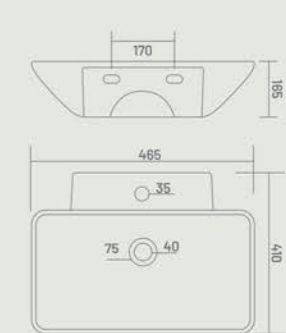
THIN RIM  
DESIGN



**MONO**  
Table Top Basin  
18" x 16" x 6"



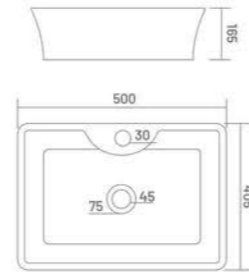
TABLE TOP /  
WALL HUNG  
BASIN



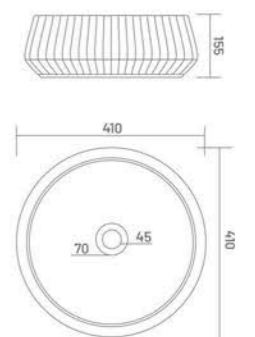




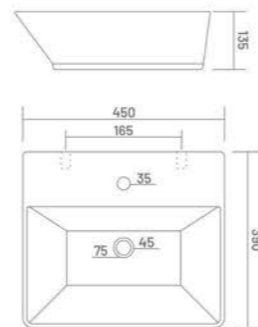
**SPIRIT GOLD**  
Table Top Basin  
20" x 16" x 7"



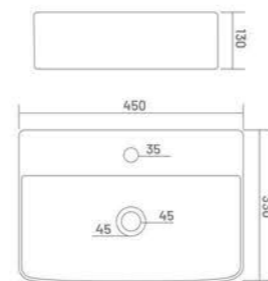
**CERA**  
Table Top Basin  
16" x 16" x 6"



**LENOVA**  
Table Top / Wall Hung Basin  
18" x 15" x 5"

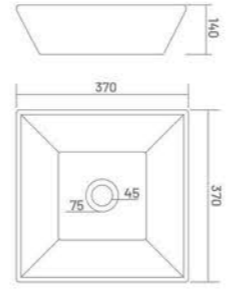


**ZEN**  
Table Top Basin  
18" x 13" x 5"

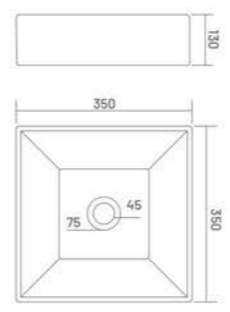




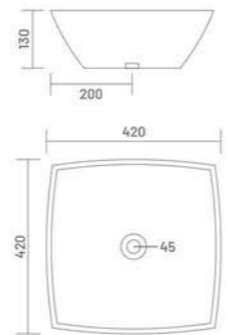
**ALVIN**  
Table Top Basin  
15" x 15" x 5"



**RIYO**  
Table Top Basin  
14" x 14" x 5"



**SONY**  
Table Top Basin  
14" x 14" x 6"





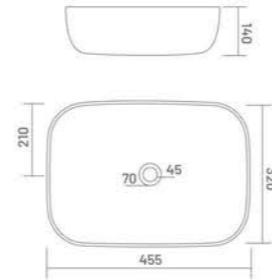
NEW ARRIVAL



**GENX**  
Table Top Basin  
18" x 13" x 5"



THIN RIM DESIGN



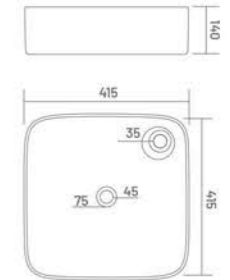
NEW ARRIVAL



**ANTILA**  
Table Top Basin  
16" x 16" x 6"



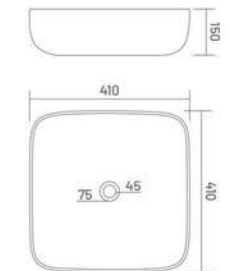
THIN RIM DESIGN



**CAMPUS**  
Table Top Basin  
16" x 16" x 6"



THIN RIM DESIGN



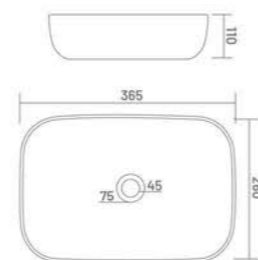
NEW ARRIVAL



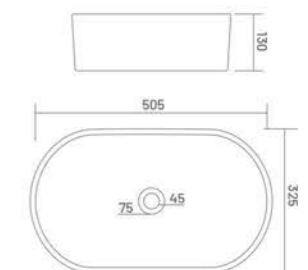
**ALEX**  
Table Top Basin  
14" x 10" x 4"



THIN RIM DESIGN

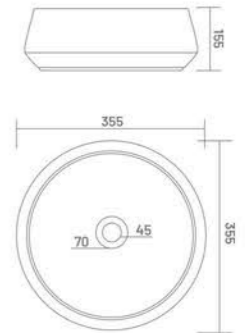


**CAPSULE**  
Table Top Basin  
20" x 13" x 5"





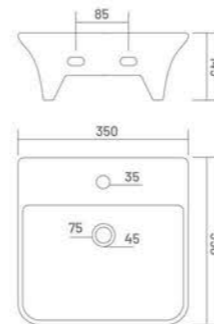
**VITARA**  
Table Top Basin  
14" x 14" x 6"



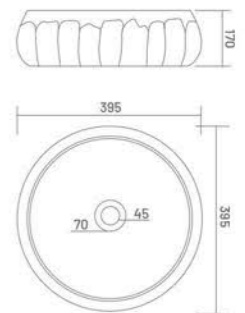
**LEXO**  
Table Top Basin  
00" x 00" x 00"



TABLE TOP /  
WALL HUNG  
BASIN



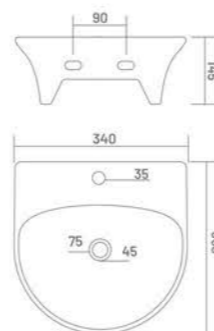
**TITLE**  
Table Top Basin  
15" x 15" x 7"



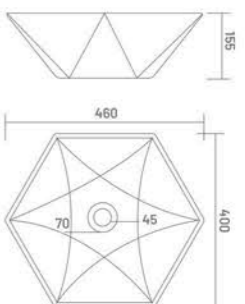
**SEMI**  
Table Top Basin  
00" x 00" x 00"



TABLE TOP /  
WALL HUNG  
BASIN



**STAR**  
Table Top Basin  
18" x 16" x 6"

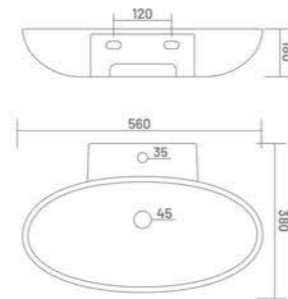




**AFFIL**  
Table Top / Wall Hung Basin  
22" x 15" x 7"



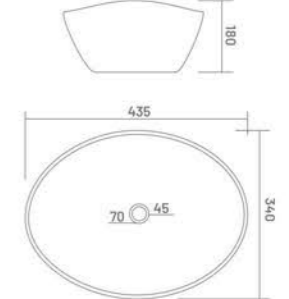
TABLE TOP /  
WALL HUNG  
BASIN



**SPENZO**  
Table Top Basin  
17" x 14" x 7"



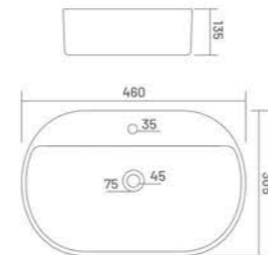
THIN RIM  
DESIGN



**CRUZE**  
Table Top Basin  
18" x 12" x 6"



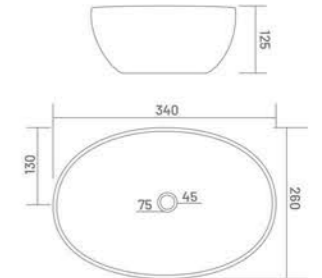
TABLE TOP /  
WALL HUNG  
BASIN



**LAKE**  
Table Top Basin  
14" x 10" x 5"



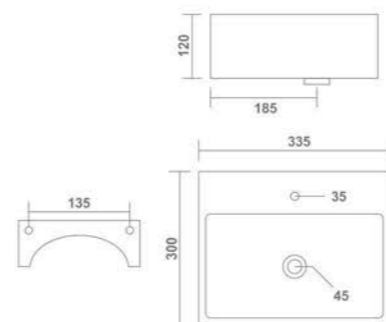
THIN RIM  
DESIGN



**LEO**  
Table Top / Wall Hung Basin  
13" x 12" x 5"



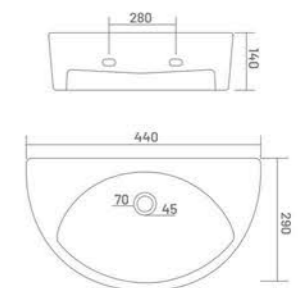
TABLE TOP /  
WALL HUNG  
BASIN



**NIKI**  
Table Top / Wall Hung Basin  
18" x 12" x 6"

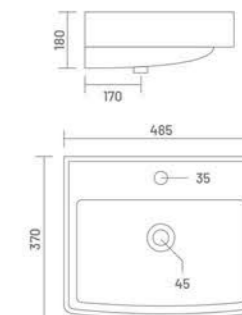


TABLE TOP /  
WALL HUNG  
BASIN

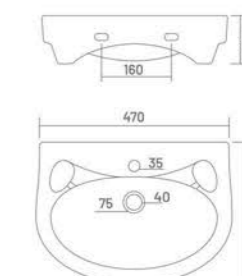




**RIWA**  
Wall Hung Basin  
19" x 15" x 7"

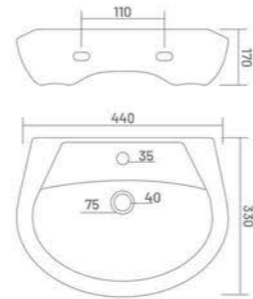


**ROYAL**  
Wall Hung Basin  
18" x 14" x 7"

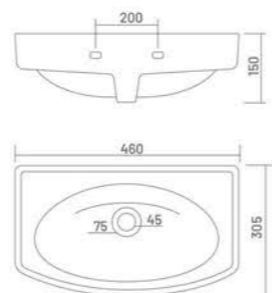




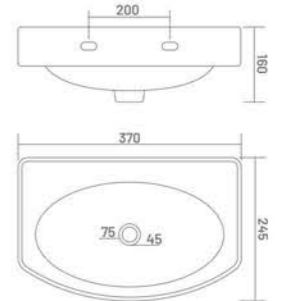
**SHARP**  
Wall Hung Basin  
18" x 13" x 7"



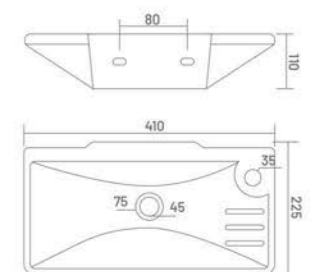
**STEFIN**  
Wall Hung Basin  
18" x 12" x 6"



**SHALLY**  
Wall Hung Basin  
15" x 10" x 6"

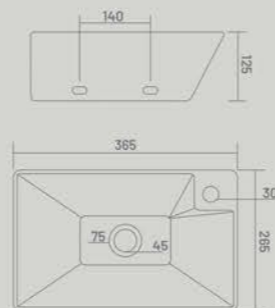


**SHIPLA**  
Wall Hung Basin  
16" x 9" x 4"





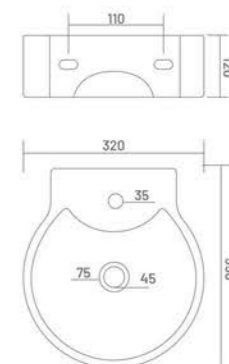
**SOGO**  
Wall Hung Basin  
00" x 00" x 00"



**FLORA**  
Wall Hung Basin  
00" x 00" x 00"



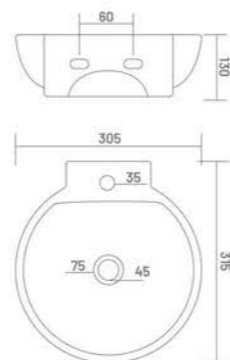
**AMPLE**  
Wall Hung Basin  
13" x 14" x 5"



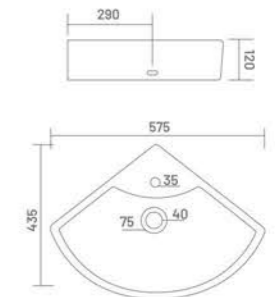




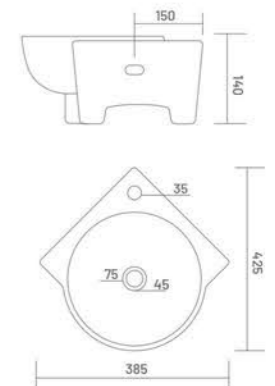
**TECCO**  
Wall Hung Basin  
12" x 12" x 5"



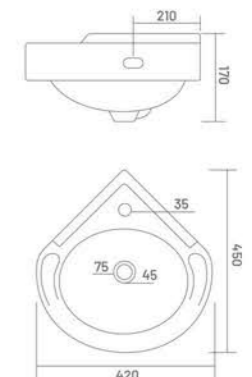
**SONA**  
Wall Hung Basin  
23" x 17" x 5"



**MOTTO**  
Wall Hung Basin  
15" x 17" x 6"

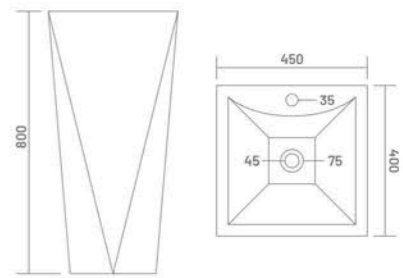


**SATIN CORNER**  
Wall Hung Basin  
17" x 18" x 7"

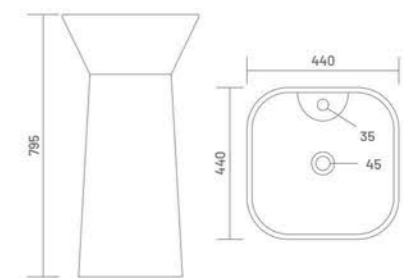




**DIAMOND**  
One Piece Basin  
18" x 16" x 32"

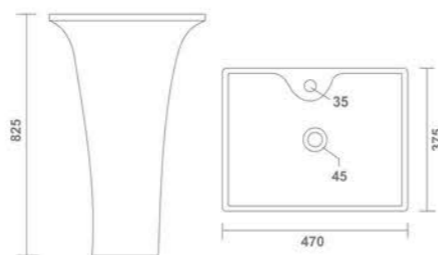


**CRETA**  
One Piece Basin  
18" x 18" x 32"

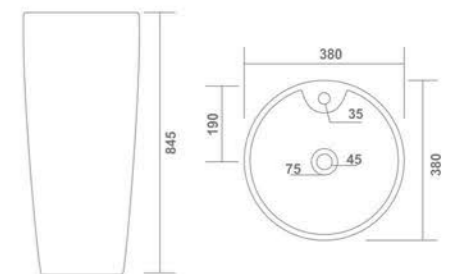




**RICH**  
One Piece Basin  
19" x 15" x 33"

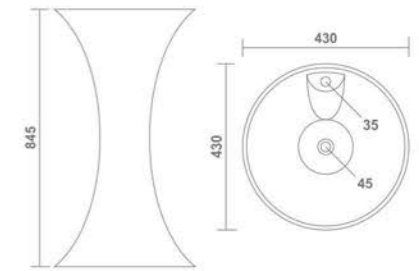


**SCORPIO**  
One Piece Basin  
15" x 15" x 34"

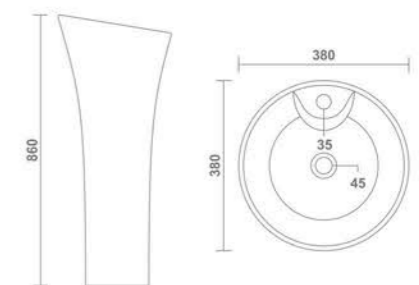




**TOTO**  
One Piece Basin  
17" x 17" x 34"



**SESA**  
One Piece Basin  
15" x 15" x 34"



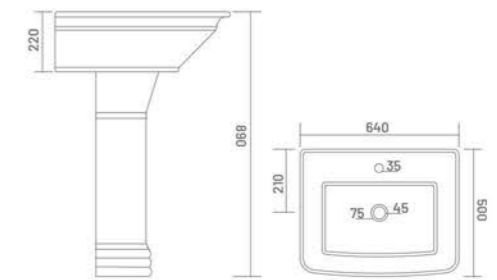


 **RADO-S**  
One Piece Closet  
26" x 15" x 30"  
Center of outlet to wall 9"/12"

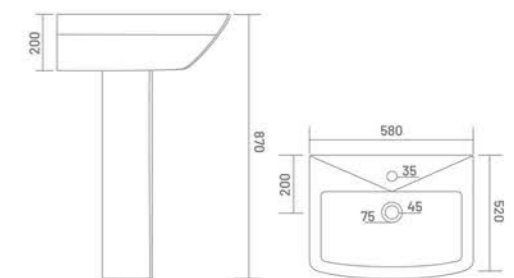
 **WINGO**  
Wash Basin Pedestal  
22" x 16" x 33"



**SENISTO GOLD**  
Wash Basin Pedestal  
25" x 20" x 36"

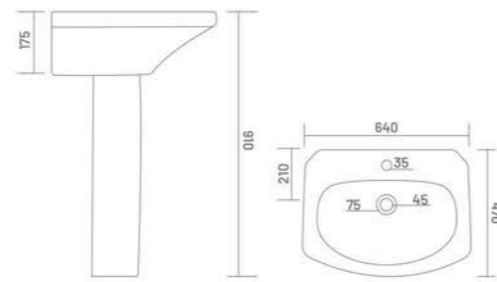


**DIAMOND**  
Wash Basin Pedestal  
23" x 21" x 35"

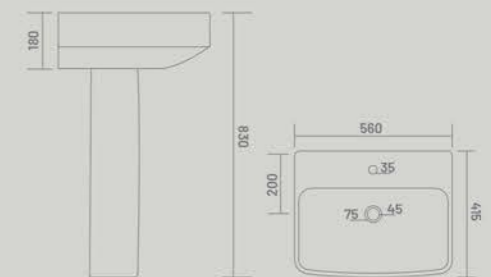




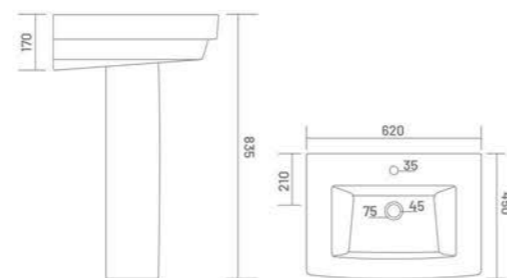
**RAPID**  
Wash Basin Pedestal  
25" x 19" x 36"



**WINGO**  
Wash Basin Pedestal  
22" x 16" x 33"

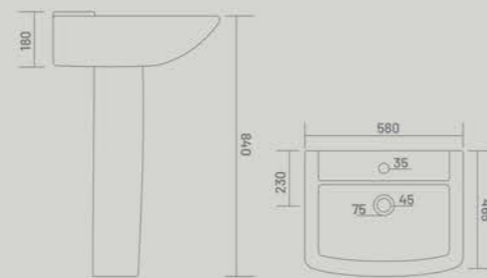


**KOYO**  
Wash Basin Pedestal  
25" x 18" x 33"

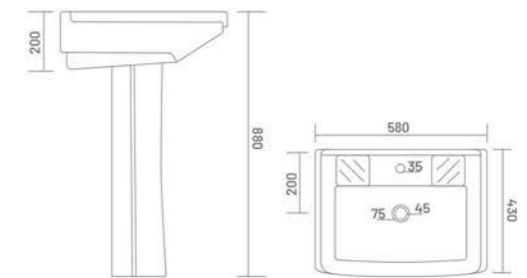




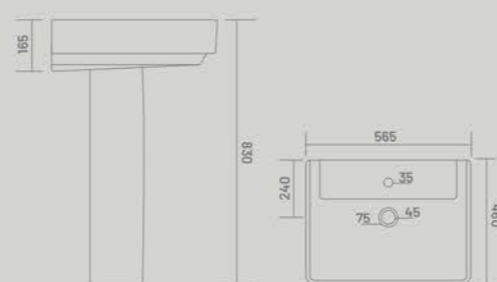
**MAPS**  
Wash Basin Pedestal  
23" x 18" x 34"



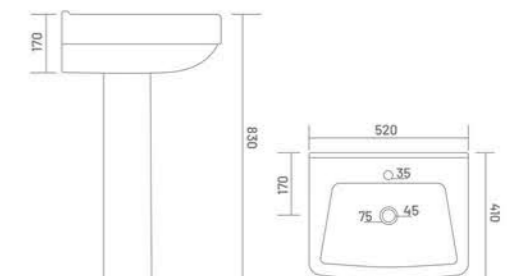
**SOPHIA**  
Wash Basin Pedestal  
23" x 17" x 35"



**SONATA**  
Wash Basin Pedestal  
22" x 18" x 33"



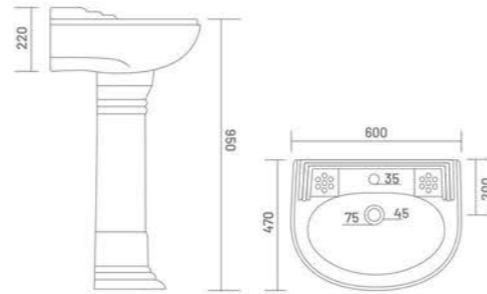
**VOX**  
Wash Basin Pedestal  
20" x 16" x 33"



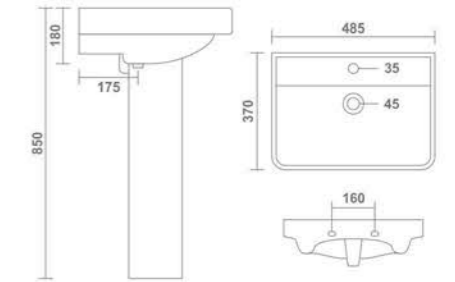




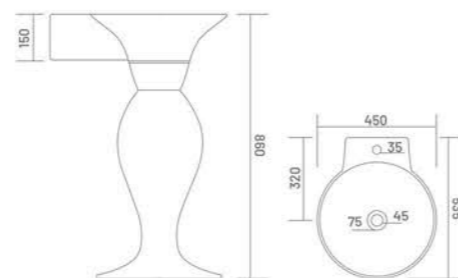
**SERENA**  
Wash Basin Pedestal  
24" x 19" x 39"



**RIWA**  
Wash Basin Pedestal  
20" x 15" x 34"



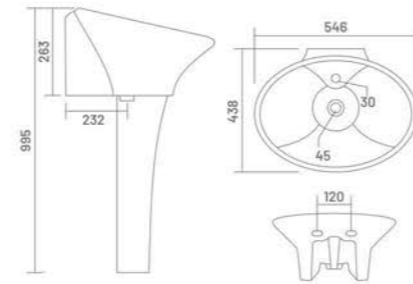
**DOLPHIN**  
Wash Basin Pedestal  
18" x 21" x 34"



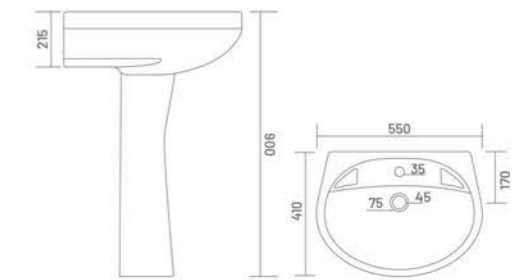
**JOYO**  
Wash Basin Pedestal  
18" x 14" x 33"



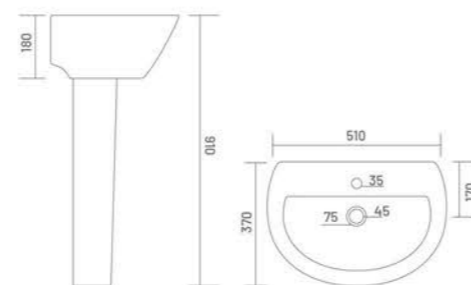
**SPENTA**  
Wash Basin Pedestal  
00" x 00" x 00"



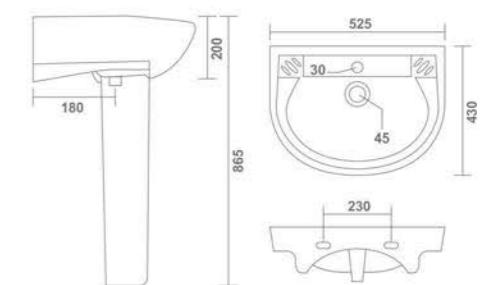
**MINAL**  
Wash Basin Pedestal  
22" x 16" x 36"



**SCOOTY**  
Wash Basin Pedestal  
20" x 15" x 36"



**SAMITE**  
Wash Basin Pedestal  
21" x 17" x 35"





**LUNAR-S**

One Piece Closet  
26" x 15" x 30"  
Center of outlet to wall 9"/12"

**DOVE**

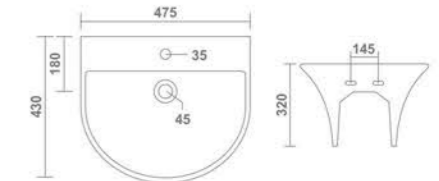
Half One Piece Basin  
19" x 17" x 13"



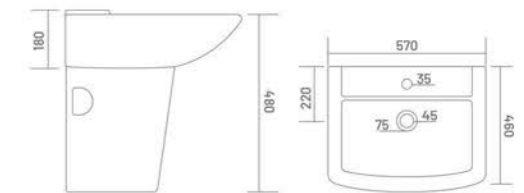
**SALSA**  
Half One Piece Basin  
18" x 18" x 14"



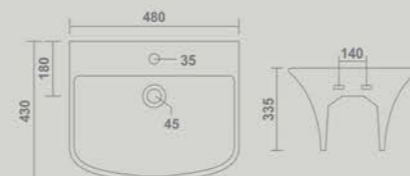
**DOVE**  
Half One Piece Basin  
19" x 17" x 13"



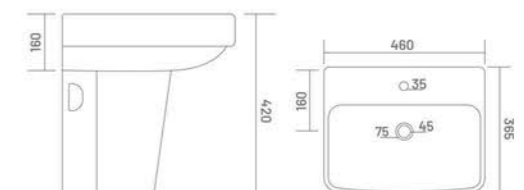
**MAPS**  
Half One Piece Basin  
23" x 19" x 19"



**DOVEL**  
Half One Piece Basin  
19" x 17" x 13"

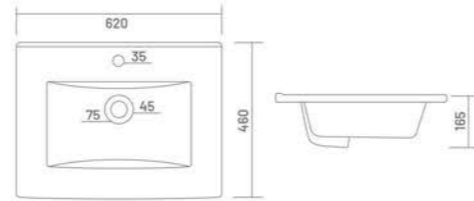


**JOYO**  
Half One Piece Basin  
18" x 14" x 19"

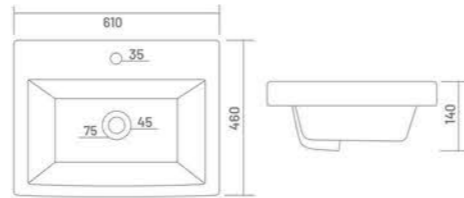




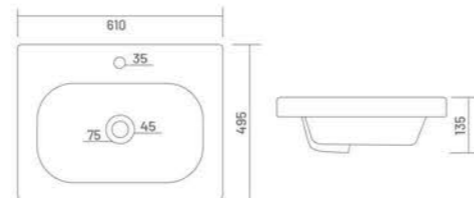
**REX**  
Counter Top Basin  
25" x 19" x 7"



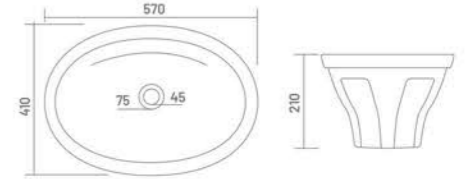
**SENDY**  
Counter Top Basin  
24" x 18" x 6"



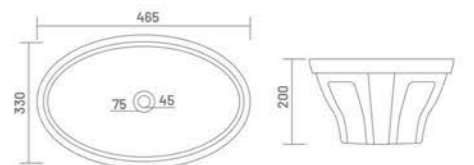
**BELLY**  
Counter Top Basin  
24" x 18" x 5"



**REMBO**  
Counter Top Basin  
23" x 16" x 8"

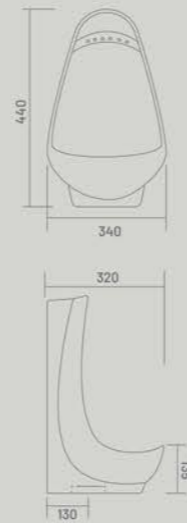


**SIMPLE**  
Under Counter Basin  
19" x 13" x 8"

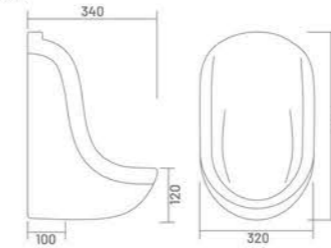




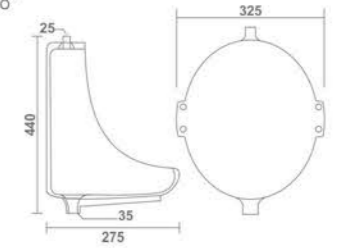
**WIND**  
Urinal  
14" x 13" x 18"



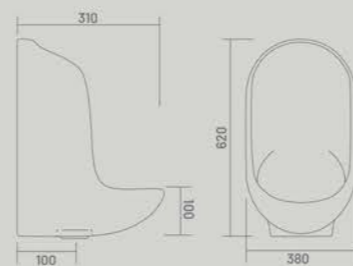
**NANO LARGE**  
Urinal  
13" x 13" x 17"



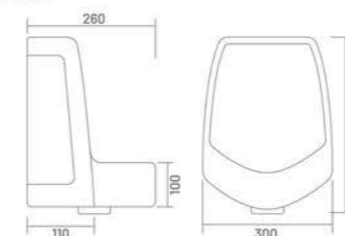
**FLAT BACK**  
Urinal  
13" x 11" x 18"



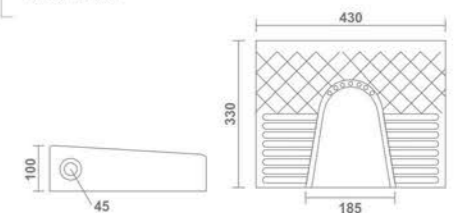
**LARGE URINAL**  
Urinal  
15" x 12" x 25"



**CORNER URINAL**  
Urinal  
12" x 10" x 14"

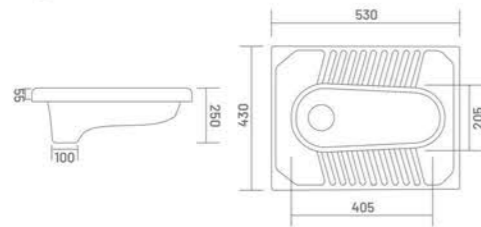


**SQUATTING**  
Urinal  
17" x 13" x 4"

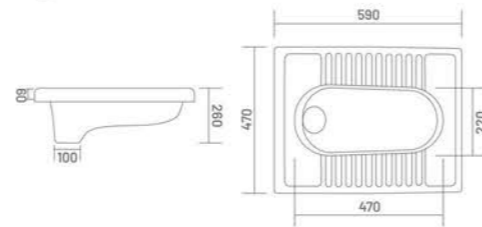




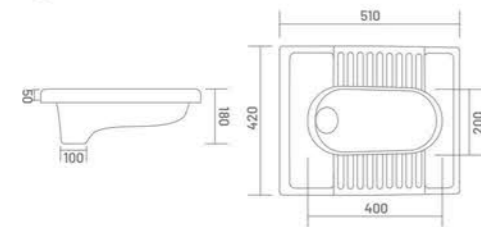
**ORISSA PAN - 20"**  
Pan  
20" x 17" x 10"



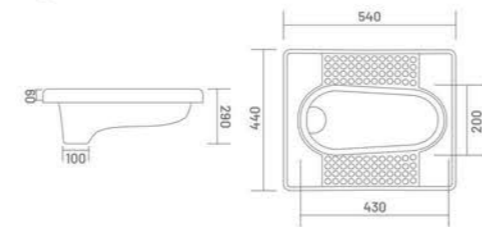
**ORISSA PAN - 23"**  
Pan  
23" x 19" x 10"



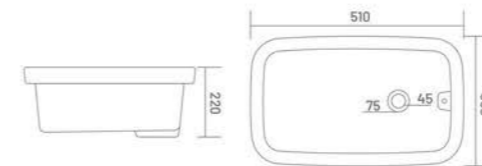
**CT PAN - 20"**  
Pan  
20" x 17" x 7"



**AQUA PAN - 21"**  
Pan  
21" x 18" x 12"



**LAB SINK**  
20" x 15" x 8"



**CISTERN - 001**



**ONE PIECE FITTING**



**S-TRAP**



**P-TRAP**



# DESIGNER COLLECTION

*Beyond Your  
Imagination...*





SCORPIO - 905



SCORPIO - 902



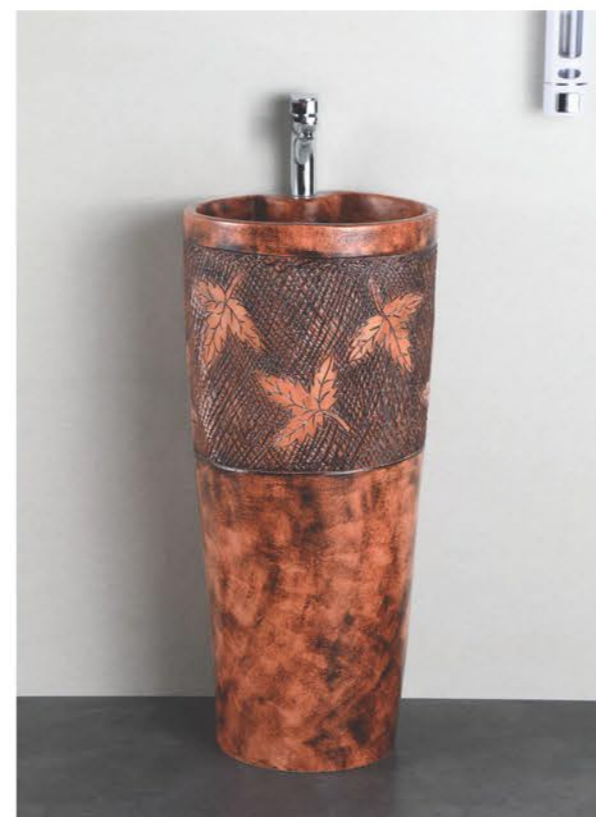
SCORPIO - 906



SCORPIO - 907



SCORPIO - 911



SCORPIO - 914



SCORPIO - 915



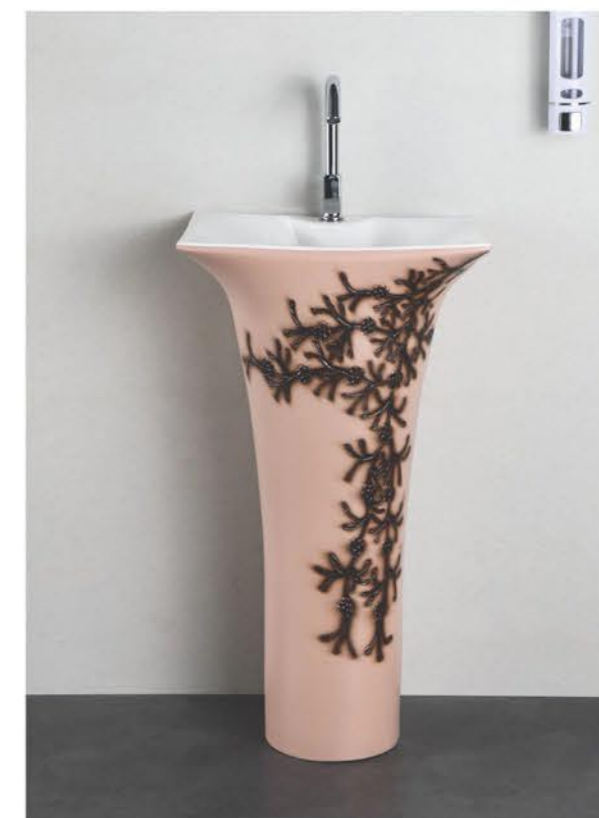
SCORPIO - 916



SCORPIO - 917



RICH - 701



RICH - 705



SCORPIO - 918



SCORPIO - 919



RICH - 711



RICH - 712



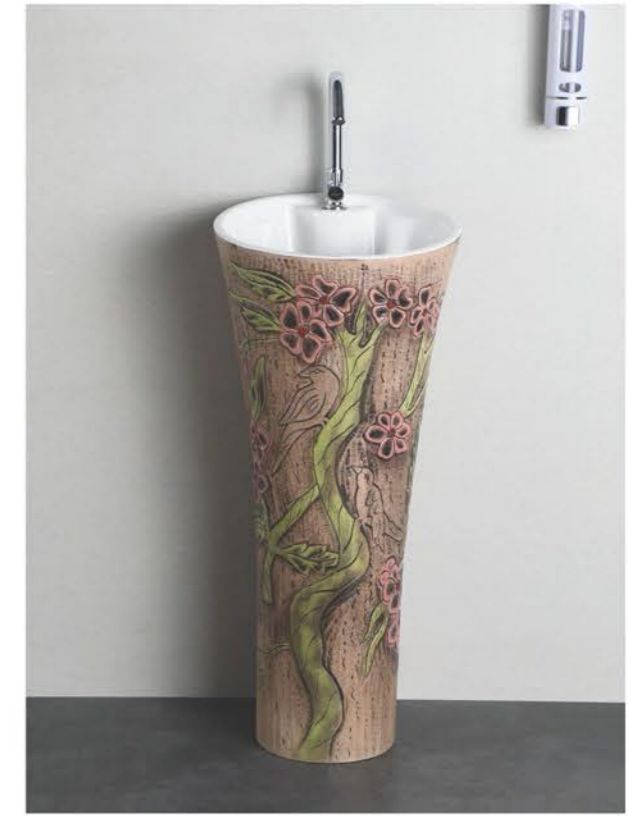
RICH - 713



RICH - 714



SESA - 504



SESA - 505



RICH - 715



RICH - 716



SESA - 509



SESA - 510



SESA - 515



SESA - 516



SESA - 519



SESA - 521



SESA - 518



SESA - 520



SESA - 522



TOTO - 602



TOTO - 609



TOTO - 610



TOTO - 611



TOTO - 612



ROCKET - 5004



RADON - 2007



ROCKET - 5002



ROCKET - 5003



RADON - 2001



RADON - 2003



ROCKET - 5005



RADON - 2005



RADON - 2006



EURO - 6004



EURO - 6003



EURO - 6005



EURO - 6006



EURO - 6007



SWIFT - 11001



SWIFT - 11006



SWIFT - 11009



ZEN - 3003



ZEN - 3004



ZEN - 3005



ZEN - 3006



CAMPUS - 001



CAMPUS - 002



CAMPUS - 013



CAMPUS - 009



CAMPUS - 011



CAMPUS - 012



CAMPUS - 014





CAPSULE - 7005



CAPSULE - 7007



CAPSULE - 7008



CAPSULE - 7009



CAPSULE - 7010



CAPSULE - 7011



GENX - 4004

Designer | Table Top Basin



GENX - 4001



GENX - 4002



GENX - 4011



GENX - 4003



GENX - 4005



GENX - 4008



GENX - 4009



GENX - 4006



GENX - 4007



GENX - 4010



GENX - 4012

Designer | Table Top Basin



GENX - 4013



GENX - 4014



GENX - 4015



GENX - 4017



TITLE - 1111



VITARA - 9001



VITARA - 9003



VITARA - 9004



VITARA - 9005



VITARA - 9006



SPENZO - 1001



SPENZO - 1007



VITARA - 9014



VITARA - 9015



SPENZO - 1010



SPENZO - 1014



VITARA - 9016



VITARA - 9017



SPENZO - 1015



SPENZO - 1016

Designer | Table Top Basin



SPENZO - 1023



SPENZO - 1018



SPENZO - 1024



SPENZO - 1025

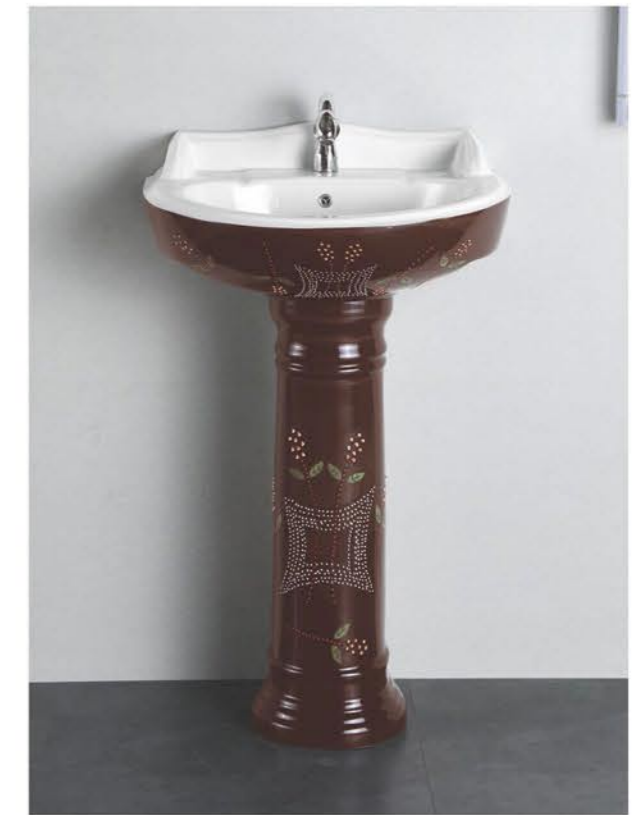


SPENZO - 1026

Designer | Wash Basin Pedestal



SERENA - 303



SERENA - 307



SERENA - 308



SERENA - 309



SERENA - 311



SERENA - 314



SERENA - 322



SERENA - 327



SERENA - 315



SERENA - 321



SERENA - 328



SERENA - 329



DOLPHIN - 401



DOLPHIN - 403



DOLPHIN - 407



DOLPHIN - 413



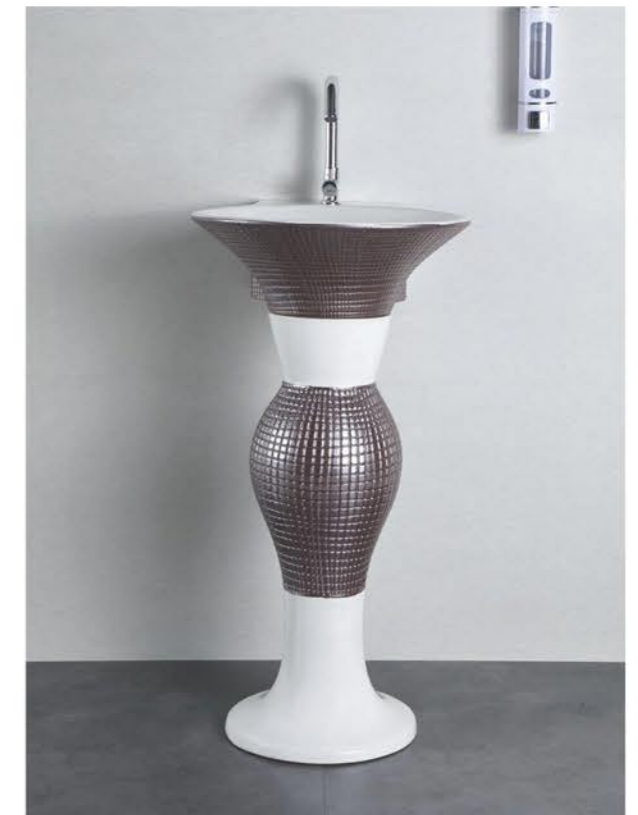
DOLPHIN - 404



DOLPHIN - 405



DOLPHIN - 414



DOLPHIN - 417



SCOP - S1



SCOP - S2



SCOP - S3



SCOP - S4



SCOP - S5



## COLOURS

### Running



WHITE



IVORY

### Special



T. BLUE



PINK



SORENTO BLUE

### Super Special

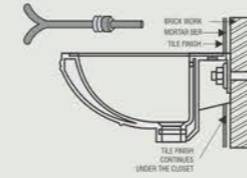


BLACK

Colours printed above may differ from original colours of ceramics. For actual selection refer samples or shade board.

## TROUBLESHOOTING GUIDE

ITEM	PROBLEM	PROBABLE REASONS	CORRECTIVE ACTIONS
Wash Basins / Table Top	1. Overflow Choked And Foul Bed Odor	Waste Coupling Used May Be Full Threaded	Waste Coupling Should Be Changed To Slot Cut Coupling
	2. Water Deposit On Tap Platform Area And Inside Bowl Area	Basin Is Not Fixed In Level Or Bracket Is Not In Level	Should Be Done By Proper Leveling
	3. There Is No Tap Hole In Basin	Tap Hole Could Be Semi Punched From Back Side	Tap Hole Should Be Created By Plumber From Semipunched Area
Ewc / Pan / Anglo Indian	1. Water Not Coming In Bowl Area While Flushing	Flush Bend Is Not Inserted Up To The End Of Inlet Hole	Insert The Flush Pipe Up To The End Of Inlet ( For Pan Closet: Check Whether Flush Pipe Is Not Covering Flush Hole Which Is In Both Side Of Inlet Wall
		Closet / Pan May Be Not Leveled	Should Be Done By Proper Leveling
One Piece Closet	1. Water Not Coming In Bowl Area While Flushing	Mechanism Inside Tank Could Not Working Properly	Change The Centre Pump Of Mechanism
		There Is No Water In Flush Tank	Increase The Ball Cock Height To The Max Level
	2. Water Is Continuously Leaking Inside The Bowl	Mechanism Inside Tank Could Not Working Properly	Change The Centre Pump Of Mechanism
	3. Water Quantity Insufficient For Effective Flushing	Ball Cock Height Adjusted At Lower Level	Increase The Ball Cock Height To The Max Level
Wallhung Water Closet	1. Water Not Coming In Bowl Area While Flushing	Flush Valve May Not Working Properly / Concealed Cistern Is Not Working Properly	Should Change Flush Valve / Concealed Cistern
		Flush Pipe Is Not Inserted Up To The End Of Inlet Hole	Insert The Flush Pipe Up To The End Of Inlet
	2. Water Is Continuously Leaking Inside The Bowl	Closet Is Not Leveled Properly	Closet Should Be In Proper Level
	3. Water Quantity Insufficient For Effective Flushing	Connection Between Closet Outlet And Drainage Pipe Is Not Proper	Should Be Done By Proper Connection By Experienced Plumber



### WALL HUNG BASIN

As per shown in the picture, the rag bolt must be grouted into the cement/concrete wall. The bolts must be fixed to the cement/concrete wall. Allow setting & checking than install it using nut and washer.

### COUNTER WASHBASIN

At the beginning

1. A skilled or experienced person should install counter lavatories.
2. Avoid using adhesive with this product.
3. Check the waste area and supply tubing if required.
4. Do not open the lavatory from its protective carton until you are ready for installation.
5. Please follow all local building and plumbing codes.



### MATERIAL & TOOLS

Measure tape, Keyhole or saber saw, Hammer, Glasses, Rags or Paper toweling, Drill (1/2 dia, drill bit or larger), Pencil, sealant, sharp knife or scissors.

### INSTALLATION OF LAVATORY

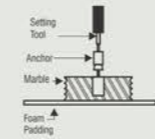
Please Note : Please install it in a way that future removal from underneath the counter top is possible without damaging the counter top.

1. Please check the desired location for clearance between the back splash, faucet, Fixture and cabinet.
2. Please cut the template.
3. Please carefully trace the template on the counter top directed.
4. Please mark the faucet hole centerline on the counter top.
5. Please drill a 1/2" pilot on the inside of the cut line.



### For Wood Counter tops:

1. Mark and pre-drill the wood screw holes at the locations shown on the template.
2. Waterproof any exposed areas of wood.



### For Marble Counter tops:

1. Position the counter top upside down on foam padding to protect the surface. Mark and drill 3/6" holes 5/8" deep at the locations shown on the template.
2. Use a setting tool and hammer to secure the anchors.



### For All Installations:

1. If the counter top has not been installed, install it at this time.
2. Drill the faucet holes according to the faucet installation instructions.
3. Install the faucet to the counter top according to the manufacture's instructions.
4. Install the drain to the lavatory according to the manufacture's instructions.

## MAINTENANCE

Like any other part of your house, the bathroom can be made to look great and made to last long if it is taken care of regularly. To make your bathroom beautiful here are some invaluable tips.

### Wash Basin :

A mild detergent can be used to wash the basin at least once a day. After washing, the basin should be wiped out clearly to avoid water stains.

### Closets :

Cleanser like Harpic can be used to clear the closet with soft plastic brush, at least once a day.

To avoid minute discoloring, after flushing the toilet give it a once over with the soft brush.

Keep the toilet brush handy in a convenient stand nearby.

In case of toilets and basins, if there has been no maintenance since long period of time, water deposits and discoloration can form on the surface of areas that get wet. In such cases, these stains/marks can be removed with the help of a solution of dilute hydrochloric acid.

Clean with a soft cotton cloth and warm water with soap.

Do not use thinner, day cleaning liquids or powder paste. Use a liquid cleaner at least twice a week.

Use brasso or car rubbing compound and then polish with a cloth to remove fine scratches.